

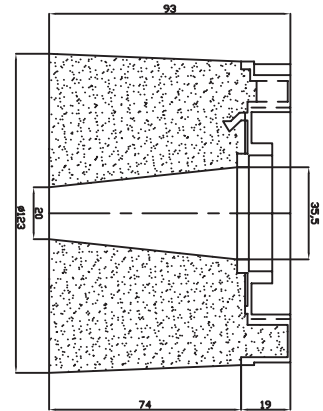

# 120 T FRM

## CODE 02V

1P = 1,69 Kg | 12P = 20,3 Kg

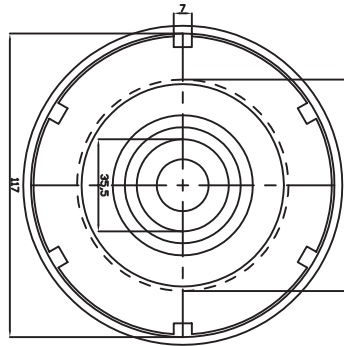











### > Tabla de equivalencias

	000	00	0	45	1	A	C	2	F	K	3	H	N	4	5	6	7	8	10	12	15	18
FEPA	16	24	30	46	60	80	100	120	150	180	220	240	280	400	500	600	700	800	1000	1200	1500	1800

### > Escala de dureza de ligantes



### > Ligantes

DISPONIBLES/ AVAILABLE	LIGANTES/ BOND MATERIAL	GRANOS/ GRITS	APLICACIONES/ APPLICATIONS	MATERIALES/ MATERIALS
	<b>VELOX</b> 	16-1800	Desbaste/ Grinding Pulido/ Polishing	Granito/ Granite, Mármol/ Marble, Caliza/ Limestone, Terrazo/ Terrazzo, Gres/ Ceramic, Arenisca/ Sandstone, Aglomerado de cuarzo/ Quartz agglomerate, Piedra artificial/ Artificial stone Pizarra/ Slate
	<b>POROX</b> 	400-1800	Pulido/ Polishing	Mármol/ Marble, Terrazo/ Terrazzo, Piedra artificial/ Artificial stone
	<b>SYNTER</b> 	Sin grano/ Without grit	Abrillantado/ Shine	Mármol/ Marble, Caliza/ Limestone, Terrazo/ Terrazzo
	<b>BRILLO</b> 	Sin grano/ Without grit	Abrillantado/ Shine	Granito/ Granite, Gres/ Ceramic, Piedra artificial/ Artificial stone
	<b>GLOSSEX</b> 	Sin grano/ Without grit	Abrillantado/ Shine	Granito/ Granite
	<b>RESIPOX</b> 	30-800	Desbaste/ Grinding Pulido/ Polishing	Granito/ Granite, Mármol/ Marble, Caliza/ Limestone, Terrazo/ Terrazzo, Gres/ Ceramic, Arenisca/ Sandstone, Aglomerado de cuarzo/ Quartz agglomerate, Piedra artificial/ Artificial stone Pizarra/ Slate
	<b>SATINEX</b> 	36-500	Efecto de envejecido/ Antiquing effect	Granito/ Granite, Mármol/ Marble, Caliza/ Limestone, Terrazo/ Terrazzo, Gres/ Ceramic, Arenisca/ Sandstone, Aglomerado de cuarzo/ Quartz agglomerate, Piedra artificial/ Artificial stone Pizarra/ Slate
	<b>POMEX</b> 	Sin grano/ Without grit	Limpeza de rayas y sombras en apomazado/ Cleaning of scratches and shadows after smoothening	Mármol/ Marble, Caliza/ Limestone, Arenisca/ Sandstone, Aglomerado de cuarzo/ Quartz agglomerate, Pizarra/ Slate
	<b>LIMPIADOR</b> 	Sin grano/ Without grit	Eliminación de restos de agente abrillantador/ Elimination of rests of the shining product	Mármol/ Marble, Caliza/ Limestone
	<b>DIAMLOX</b> 	24-1800	Desbaste / Grinding Pulido / Polishing	Granito / Granite, Mármol / Marble, Caliza / Limestone, Arenisca / Sandstone, Aglomerado de cuarzo / Quarz agglomerate
	<b>DIAMANTE</b> 	24-180	Desbaste / Grinding	Granito / Granite, Mármol / Marble
	<b>POTEA</b> 	Sin grano / Without grit	Pulido / Polishing	Granito / Granite, Mármol / Marble
	<b>BASIC</b> 	16-1800	Desbaste / Grinding Pulido / Polishing	Granito / Granite, Mármol / Marble, Caliza / Limestone, Arenisca / Sandstone, Aglomerado de cuarzo / Quarz agglomerate
	<b>CNC</b> 	24-1500	Desbaste / Grinding Pulido / Polishing	Granito / Granite, Mármol / Marble, Aglomerado de cuarzo / Quarz agglomerate