

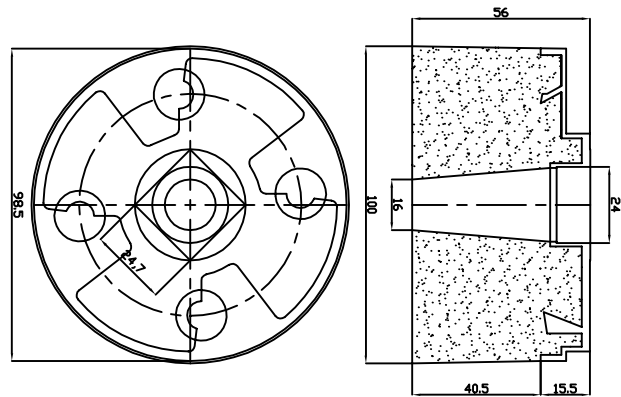

100 T BLOC

CODE 01U

1P = 0,72 Kg | 32P = 23,0 Kg













> Tabla de equivalencias

| | | | | | | | | | | | | | | | | | | | | | | |
|---|-----|----|----|----|----|----|-----|-----|-----|-----|-----|-----|-----|-----|-----|-----|-----|-----|------|------|------|------|
|  | 000 | 00 | 0 | 45 | 1 | A | C | 2 | F | K | 3 | H | N | 4 | 5 | 6 | 7 | 8 | 10 | 12 | 15 | 18 |
| FEPA | 16 | 24 | 30 | 46 | 60 | 80 | 100 | 120 | 150 | 180 | 220 | 240 | 280 | 400 | 500 | 600 | 700 | 800 | 1000 | 1200 | 1500 | 1800 |

> Escala de dureza de ligantes



> Ligantes

| DISPONIBLES/ AVAILABLE | LIGANTES/ BOND MATERIAL | GRANOS/ GRITS | APLICACIONES/ APPLICATIONS | MATERIALES/ MATERIALS |
|---------------------------|---|--------------------------|--|---|
| ✓ | VELOX  | 16-1800 | Desbaste/ Grinding Pulido/ Polishing | Granito/ Granite, Mármol/ Marble, Caliza/ Limestone, Terrazo/ Terrazzo, Gres/ Ceramic, Arenisca/ Sandstone, Aglomerado de cuarzo/ Quartz agglomerate, Piedra artificial/ Artificial stone Pizarra/ Slate |
| | POROX  | 400-1800 | Pulido/ Polishing | Mármol/ Marble, Terrazo/ Terrazzo, Piedra artificial/ Artificial stone |
| | SYNTER  | Sin grano/ Without grit | Abrillantado/ Shine | Mármol/ Marble, Caliza/ Limestone, Terrazo/ Terrazzo |
| ✓ | BRILLO  | Sin grano/ Without grit | Abrillantado/ Shine | Granito/ Granite, Gres/ Ceramic, Piedra artificial/ Artificial stone |
| ✓ | GLOSSEX  | Sin grano/ Without grit | Abrillantado/ Shine | Granito/ Granite |
| | RESIPOX  | 30-800 | Desbaste/ Grinding Pulido/ Polishing | Granito/ Granite, Mármol/ Marble, Caliza/ Limestone, Terrazo/ Terrazzo, Gres/ Ceramic, Arenisca/ Sandstone, Aglomerado de cuarzo/ Quartz agglomerate, Piedra artificial/ Artificial stone Pizarra/ Slate |
| | SATINEX  | 36-500 | Efecto de envejecido/ Antiquing effect | Granito/ Granite, Mármol/ Marble, Caliza/ Limestone, Terrazo/ Terrazzo, Gres/ Ceramic, Arenisca/ Sandstone, Aglomerado de cuarzo/ Quartz agglomerate, Piedra artificial/ Artificial stone Pizarra/ Slate |
| | POMEX  | Sin grano/ Without grit | Limpeza de rayas y sombras en apomazado/ Cleaning of scratches and shadows after smoothening | Mármol/ Marble, Caliza/ Limestone, Arenisca/ Sandstone, Aglomerado de cuarzo/ Quartz agglomerate, Pizarra/ Slate |
| | LIMPIADOR  | Sin grano/ Without grit | Eliminación de restos de agente abrillantador/ Elimination of rests of the shining product | Mármol/ Marble, Caliza/ Limestone |
| | DIAMLOX  | 24-1800 | Desbaste / Grinding Pulido / Polishing | Granito / Granite, Mármol / Marble, Caliza / Limestone, Arenisca / Sandstone, Aglomerado de cuarzo / Quarz agglomerate |
| | DIAMANTE  | 24-180 | Desbaste / Grinding | Granito / Granite, Mármol / Marble |
| | POTEA  | Sin grano / Without grit | Pulido / Polishing | Granito / Granite, Mármol / Marble |
| | BASIC  | 16-1800 | Desbaste / Grinding Pulido / Polishing | Granito / Granite, Mármol / Marble, Caliza / Limestone, Arenisca / Sandstone, Aglomerado de cuarzo / Quarz agglomerate |
| | CNC  | 24-1500 | Desbaste / Grinding Pulido / Polishing | Granito / Granite, Mármol / Marble, Aglomerado de cuarzo / Quarz agglomerate |